

- - +



copyright © 2022



-
-
-

-
-
-
-
-
-
-
-

7*24h

7*24h

4008-111-000

4008111000@ruijie.com.cn

doc@ruijie.com.cn



APP

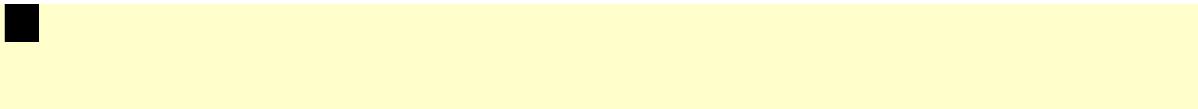

RG-S6220 3+G 0' j_K@ \$5*5

8 k.D ,'

M' A Z] 0. Q 0 0 ~ 7 v 9 r

IPv6 - ?

0' j E k? z A+X % Z] 0 j

8 E j \$ 7 7 v 0 , ' = N ~ E' w 6 S

% 0 * A

RG-S6220

3+G 0' j

-)

E

3

ln

k j

0

x n * '	10 G SFP+ Z5*1	10GB ase - T Z5*1	40G QSFP+ Z5*1	24/8G SFP FC 0	
---------	-------------------	----------------------	-------------------	-------------------	--

RG-S6220-48XS4QXS()



 RG-S6220-48XS4QXS V1.XX 10G/40G DAC Direct Attach Copper SFP+

USB2.0

RG-S6220
()
1-4 RG-S6220-48XS4QXS

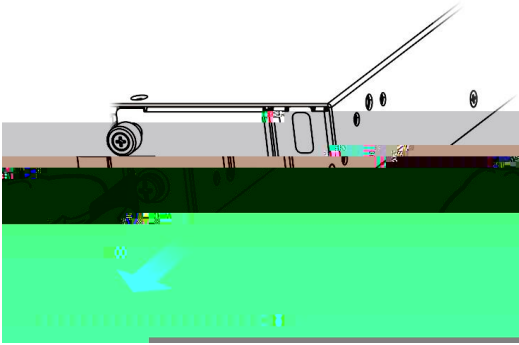

RG-S6220-48XS4QXS V1.XX

- USB Universal Serial BUS USB

	USB	USB	USB	USB
--	-----	-----	-----	-----

- Console RS-232 RJ45
- 10/100/1000M RCMI DCMI RJ45 Data Center Manageability Interface

	DCMI	PC	DCMI
--	------	----	------

DCMI

- SFP+ 48 10G QSFP+ DAC 1000Base-X
- QSFP+ 4 40G QSFP+ DAC 4x10G
- FC 8 2G/4G/8G Fibre Channel 1-8 SFP+

	Status		1 2
1	PWR1		AC
2	PWR2		

			AC
			Link up
RCMI	RCMI		Link up 1000M
			Link up 10M 100M
		/ /	

Fan



20cm



3

	RG-S6220-48XS4QXS V2.XX XX	
CPU	1.0GHz	
BOOT ROM	8MB	
Flash Memory	512MB	
SDRAM	DDR3 2GB	
	3 2+1	2
	M6220-FAN II-F	
	2 1+1	
	RG-M6220-AC460E-F	
	AC 100-240V~ 90-264V~ 50-60Hz 5.29A-2.2A	HVDC 192-290VDC 2.66A-2.03A
	<180W	

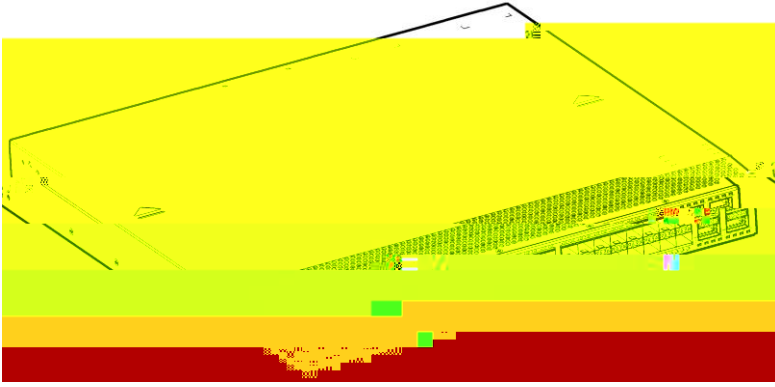



1-7 RG-

RG-S6220-48XS4QXS()

	(1*40G)		40G Link Up
			40G

RG-S6220-48XS4QXS V2.XX

RG-M6220-AC460E-F

	RG-S6220-48XS4QXS V2.XX	1	1	1	1
		1	1	2	
		1			

RG-S6220-48XS4QXS V2.XX 0 50
 S6220-48XS4QXS V2.00
 3

RG-S6220-48XS4QXS V2.XX M6220-FAN II-F

1-10 RG-S6220-48XS4QXS V2.XX

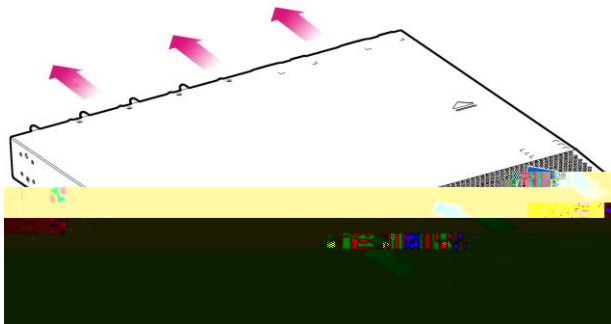

		20cm
	2	

	RG-S6220-48XT4QXS	
CPU	1.0GHz	
BOOT ROM	8MB	
Flash Memory	512MB	
SDRAM	DDR3 1GB	
	4	3
	3+1	
	M6220-FAN-F	
	2	1+1
	RG-M6220-AC460E-F	
	AC	HVDC
	100-240V~	192-290VDC
	90-264V~	2.66A-2.03A
	50-60Hz	
	5.29A	
	<450W	

	A B
SFP+	
QSFP+	
FC	
10Gbase-T	A
EMC	GB/T 9254.1
	GB 4943.1
	0 to 45°C
	-40 to 70°C
	10% 90% RH
	11KG 4 2
	440 * 500 * 44 L * W * H mm 1RU

RG-S6220-48XT4QXS 40G DAC Direct Attach Copper QSFP+ 3
B

RG-S6220-48XT4QXS

- 2 1+1
- 4 3+1

1-11 RG-S6220-48XT4QXS

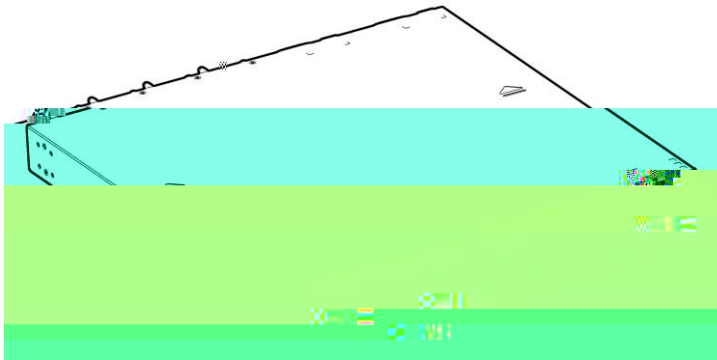

1-12 RG-S6220-48XT4QXS

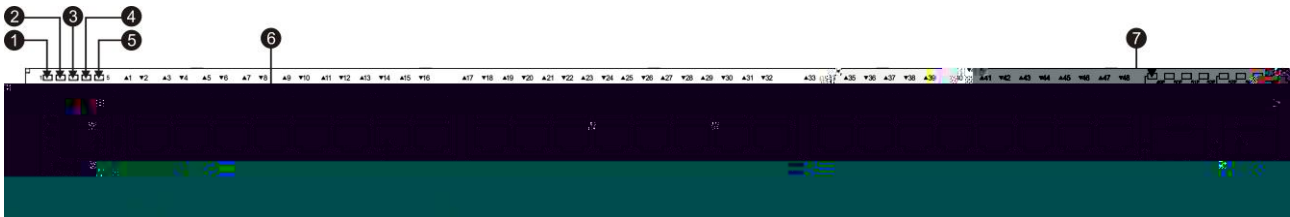

PWR1	40G QSFP+
PWR2	10/100/1000Base-T RCM
RCMI	Console
	10GBASE-T RJ45
10GBASE-T	⑪ 40G QSFP+

- 10GBase-T 48 10GBase-T 1000Base-T 100Base-TX
- QSFP+ 4 40G QSFP+ DAC 4x10G

	Status		1
			2
1	PWR1		AC
2	PWR2		AC
		Link up	
RCMI	RCMI	Link up	1000M



20cm



3

	RG-S6220-24XS
CPU	1.0GHz



USB2.0

RG-S6220

() ,
1-19 RG-S6220-24XS

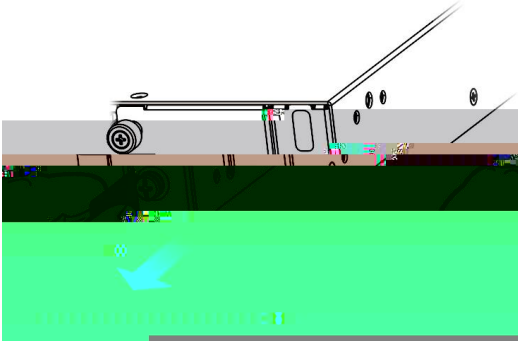

RG-S6220-24XS

- USB Universal Serial BUS USB

	USB	USB	USB	USB
---	-----	-----	-----	-----

- Console RS-232 RJ45

- 10/100/1000M RCMi DCMI RJ45 Data Center Manageability Interface

	DCMI	PC	DCMI
---	------	----	------

 DCMI

RCMI	RCMI		Link up	
			Link up	1000M
			Link up	10M 100M
		/ /		
	Fan		3	
		1		
		2		3
SFP+	1F—24F		Link	
			10G/1G	Link Up
			10G/1G	

RG-S6220



ō ^

RG-S6224820A#e180F2r/CZ_3-4B2V/820#A#CDE,100M]2m.02958,09TV82B.724d664# c%0ŸF, B' b i#N`

è B' 3+ G7Q /P 02228 9088 10D871f 46.8231 436 EMC <332B084704D429924A>T>P

 M6220-02QXS QSFP+ 40G 4x10G

EMC	GB/T 9254.1
	GB 4943.1
	0 to 50°C
	-40 to 70°C
	10% 90% RH
	0.5KG
	224.5 * 110 * 36.8 L * W * H mm

 M6220-08FC	FC	Ethernet					
 M6220-08FC	Ethernet		10G SFP+	1G SFP	10G SFP+		1G SFP
 M6220-08FC	10G		DAC	Direct Attach Copper	SFP+	1	3
5		B					

1-24 M6220-08XT

Status
1~8
10GBASE-T RJ45

M6220-08XT 8 RJ45 10GBASE-T 1000BASE-T 100BASE-TX

	Status		
	1-8		Link up 10G/1G/100M Link up

10Gbase-T 1000Base-T 100Base-TX



A

1-26 M6220-FAN II-F

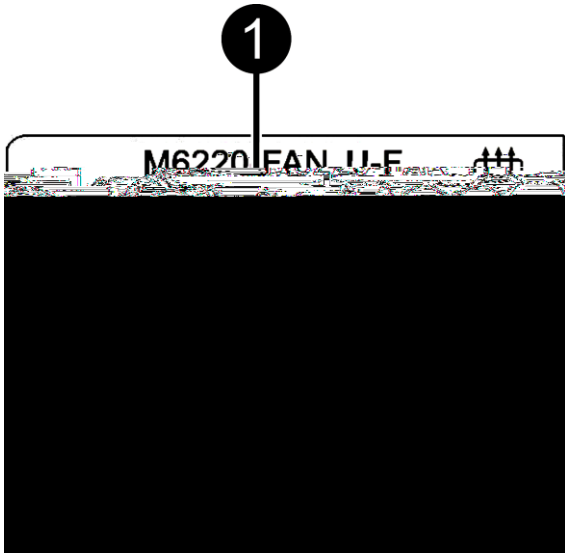

Status

	Status		

	M6220-FAN II-F
	20CFM
	18000RPM
	6W
	0.25KG
	166 * 55.7 * 41.2(mm)

M6220-AC460E-F

RG-S6220

RG-S6220

M6220-AC460E-F

M6220-AC460E-F

10A

	M6220-AC460E-F AC	M6220-AC460E-F HVDC
	100V-240V~ 50/60Hz	NA
	90-264V~ 47-63Hz	192-290V
	460W	460w
	0.9	



RG-S6220



120VAC

0.5mA

240VAC

1.0mA

RG-S6220

-
-
-
-

RG-S6220

RG-S6220

RG-S6220

20cm

3

RG-S6220

-
-
-

RG-S6220

--	--	--

RG-S6220-24XS

0.5 μ m	/ m ³	3.5 \times 10 ⁶
5 μ m	/ m ³	3 \times 10 ⁴

-
-
-
-

 RG-S6220



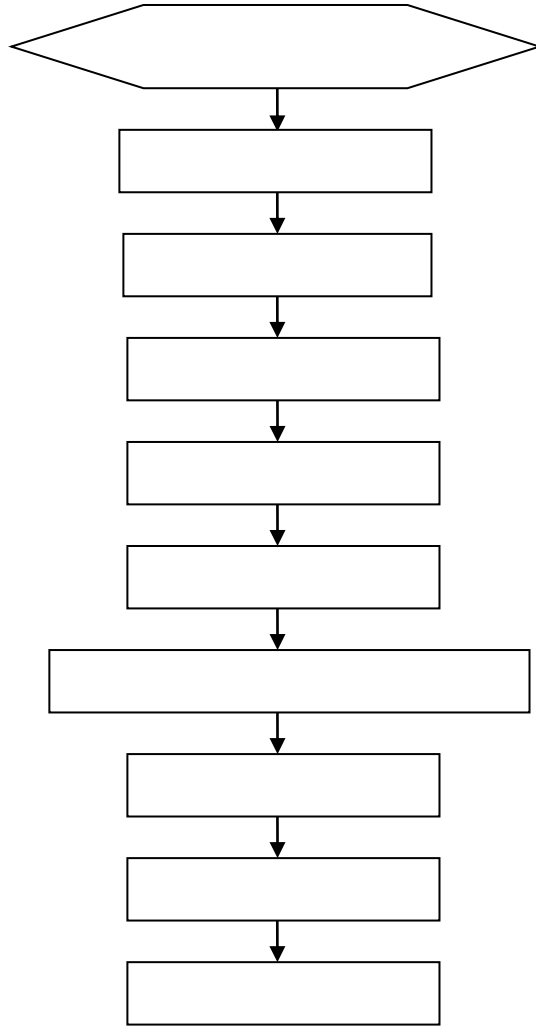

-
-
-
-

-
-
-
-
-
-
-
-
-
-

5mm

RG-S6220

10mm

-
-
-
-

1 L 8 M4*8FMO

2 4 M4*8FMO

3-1

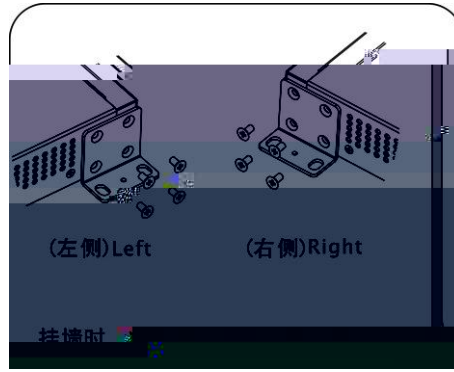
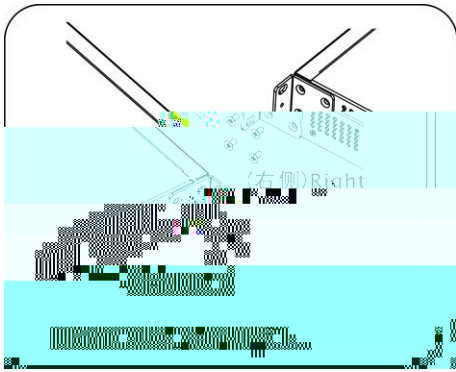

RG-S6220

EIA

19

RG-S6220

3-2

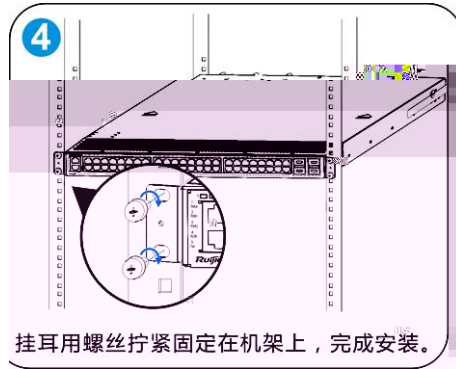
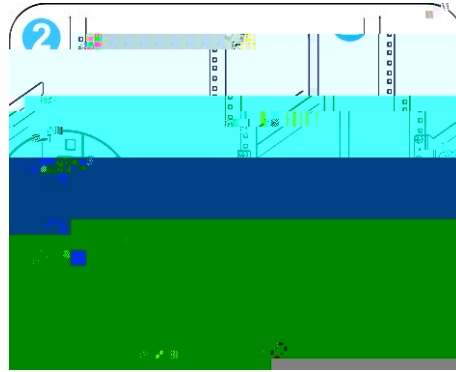
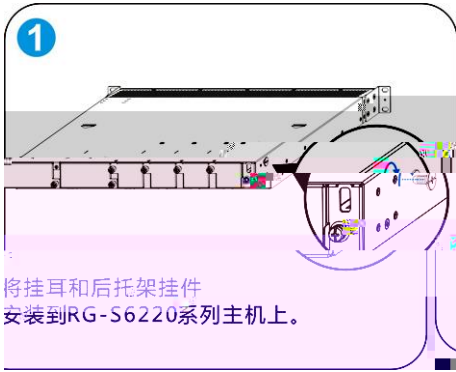

800mm – 1200mm

19

1

4

2

3-3

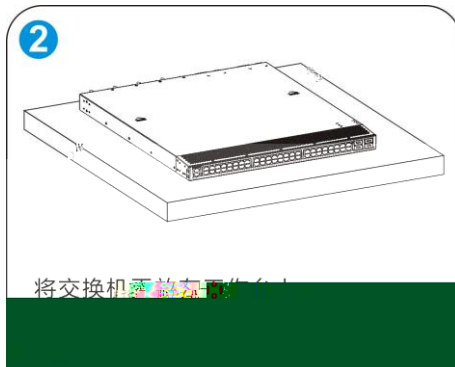
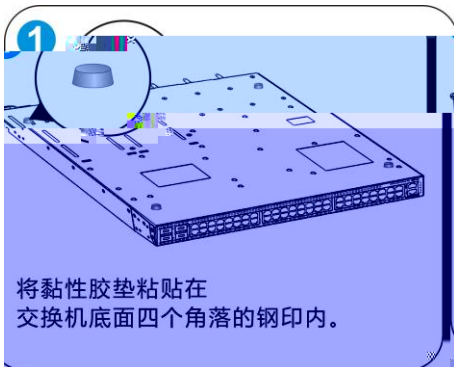

1)

.....

1)

2)

3)

3-4



.....

1)

2)

3)

3-5

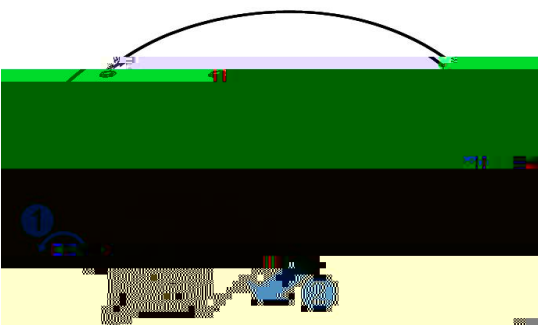

M6220-FAN-F

M6220

1) RG-S6220

2)

3)

3-6

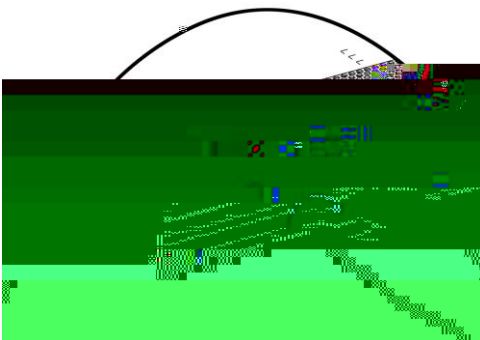
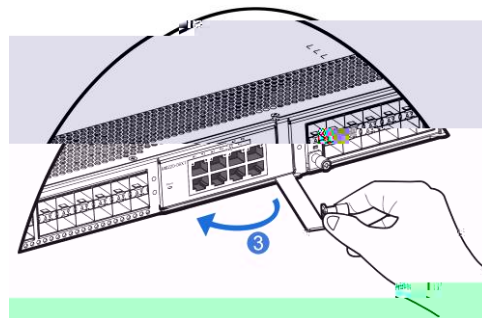
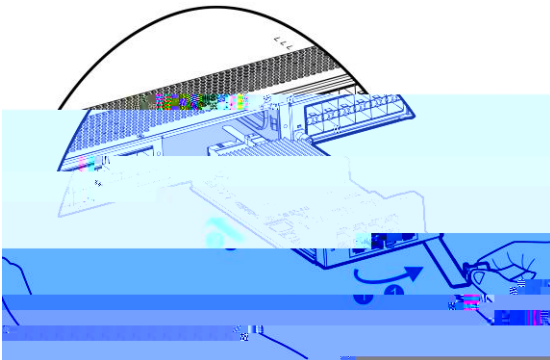

1) RJ45

2)

3)

4)

3-7

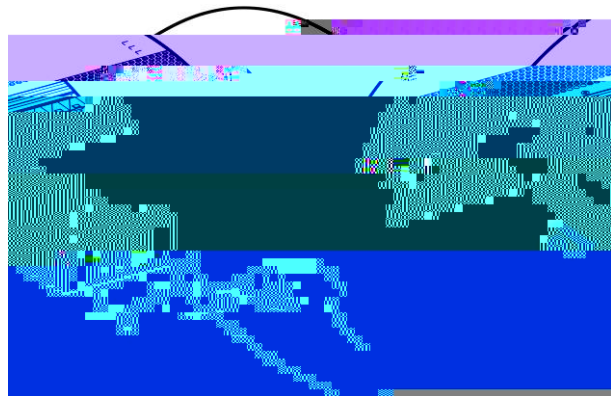
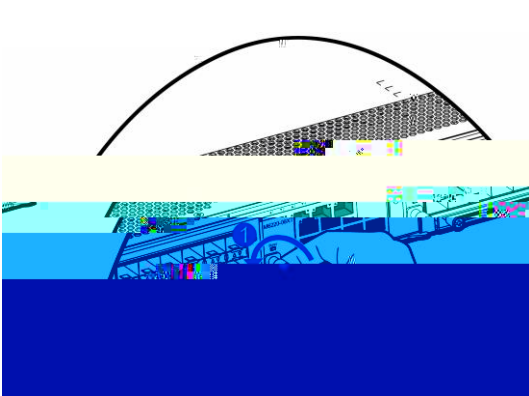

M6220

1)

2)

“ ”

3-8

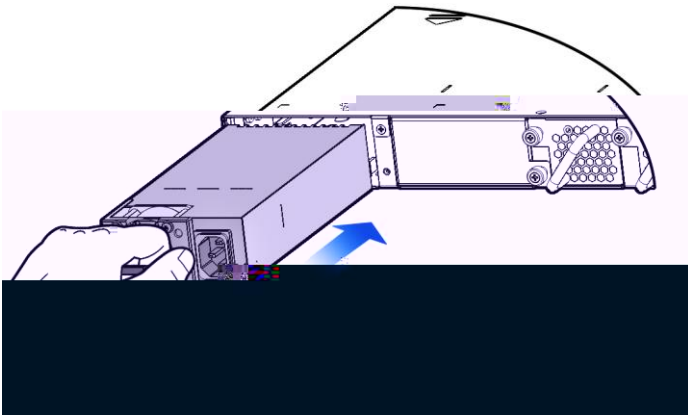

1)

2)

3-9

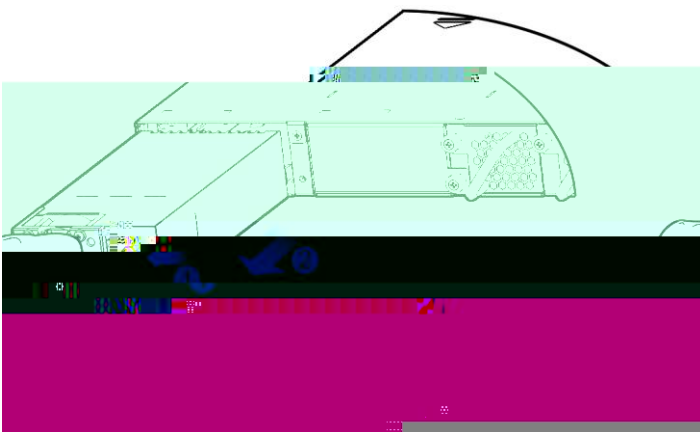

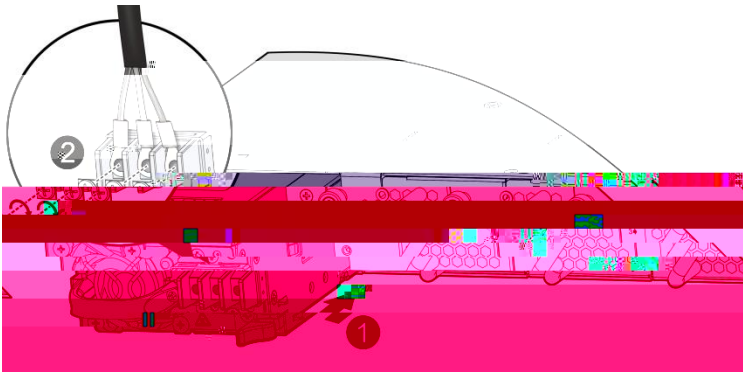

3-11

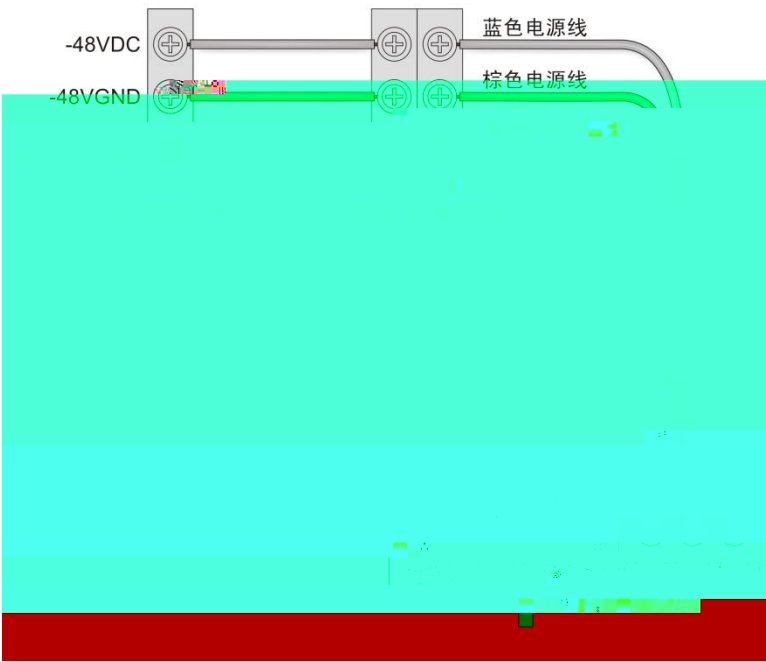

1

2

" "



1

2

(3-12)

3

RG-M6220-DC460E-F

RG-S6220

■

■

■

1

1

2.5

12AWG

	RJ-45	Console	DB9
	9600	8	1

■

■

- 1) RJ45 RCM1
- 2) ,
- 3) RJ45

■

■

■

- 1)
- 2)
- 3)

-
-
-
-
-

20

-
-
-
-

-
-
-

PC Console 4-1
4-1

- 1) DB-9 PC
- 2) RJ45 Console

■ PC PC Windows3.1 Terminal Windows 95/98/NT/2000/XP

■ 9600 8 1

- 1) “ ”_“ ”_“ ”_“ ”_“ ” 4-2

4-2

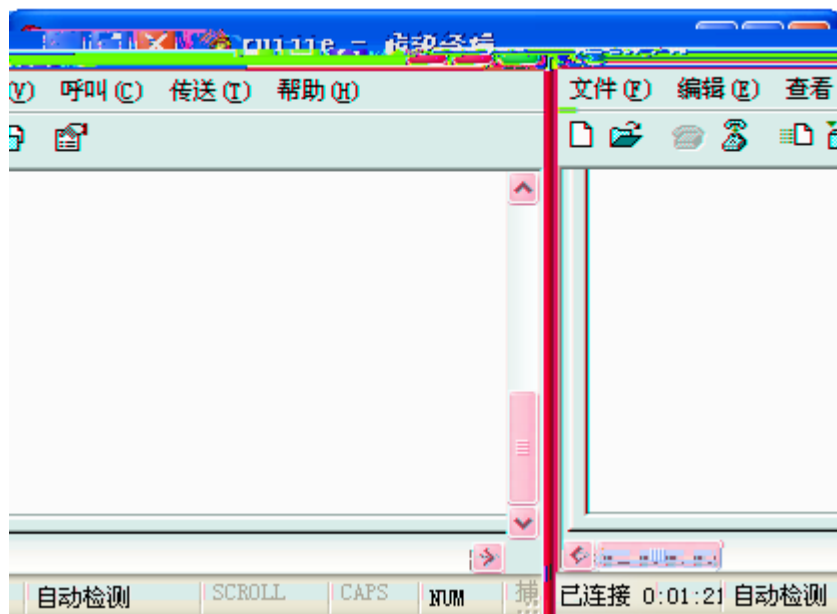

-
-
-
-
-

-
-

PC

RG-S6220

■

■

RG-S6220

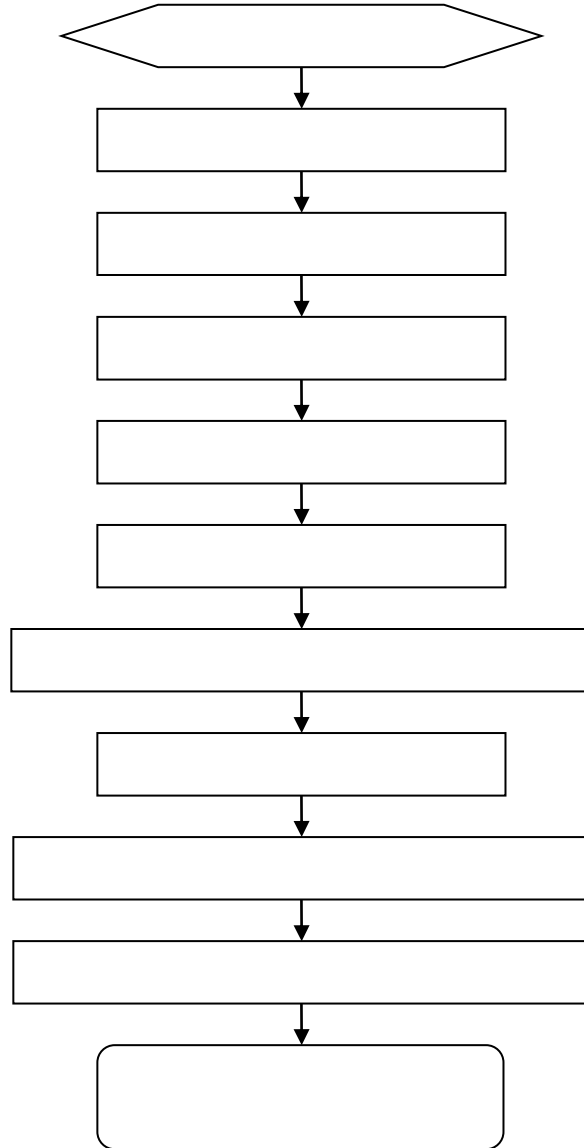

Status

Status

link

1

2

1310nm

10GBASE-T/1000BASE-T/100BASE-TX

MDI/MDIX

Crossover

10GBASE-T IEEE 802.3an
4 10GBASE-T

10GBASE-T 4



QSFP+ FC
SFP+ 40G QSFP+ FC

SFP Mini-GBIC

SFP+ 40G
Mini-GBICFC SFP

	(nm)		(μm)	(MHz· km)		(dbm)		(dbm)	
						min	max	min	max

	(nm)		(um)	(MHz- km)		(dBm)		(dBm)		DDM (Yes/No)
						min	max	min	max	
FC2G-SFP-SR-MM850	850	(LC)	62.5/125	N/A	300m(1G) 150m(2G)	-9	-3	-18	0	YES
			50/125	N/A	550m(1G) 300m(2G)					
FC4G-SFP-SR-MM850	850	(LC)	62.5/125	N/A	300m(1G) 150m(2G) 70m(4G)	-9	-2.5	-15	0	YES
			50/125	N/A	550m(1G) 300m(2G) 150m(4G)					
FC8G-SFP-SR-MM850	850	(LC)	50/125	N/A	300m(2G) 150m(4G) 50m(8G)	-8.2	-3	-18	0	YES
			50/125	OM3	500m(2G) 380m(4G) 150m(8G)					

C-1

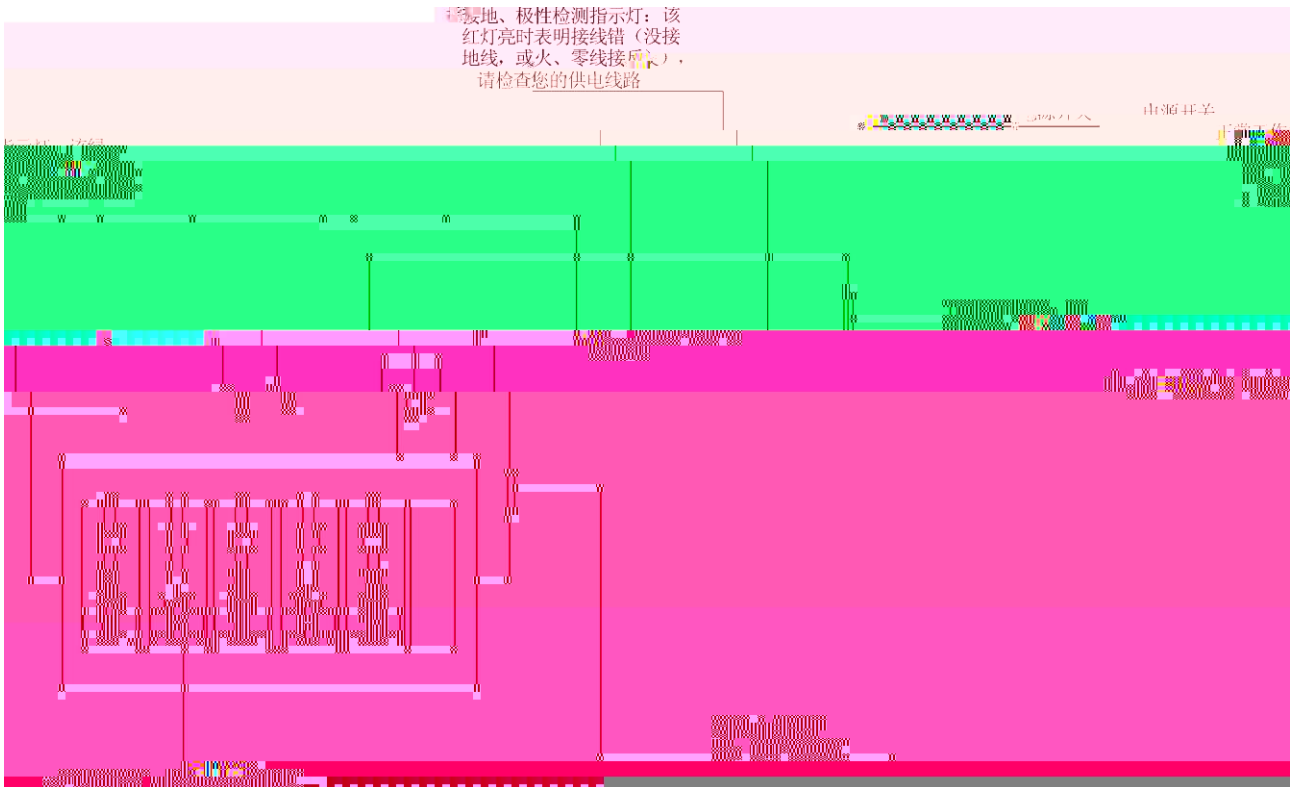

-
-
-

PE

PE

PE



■

30mm

■

■

■

■

D-2

D-2



■

D-3

D-3

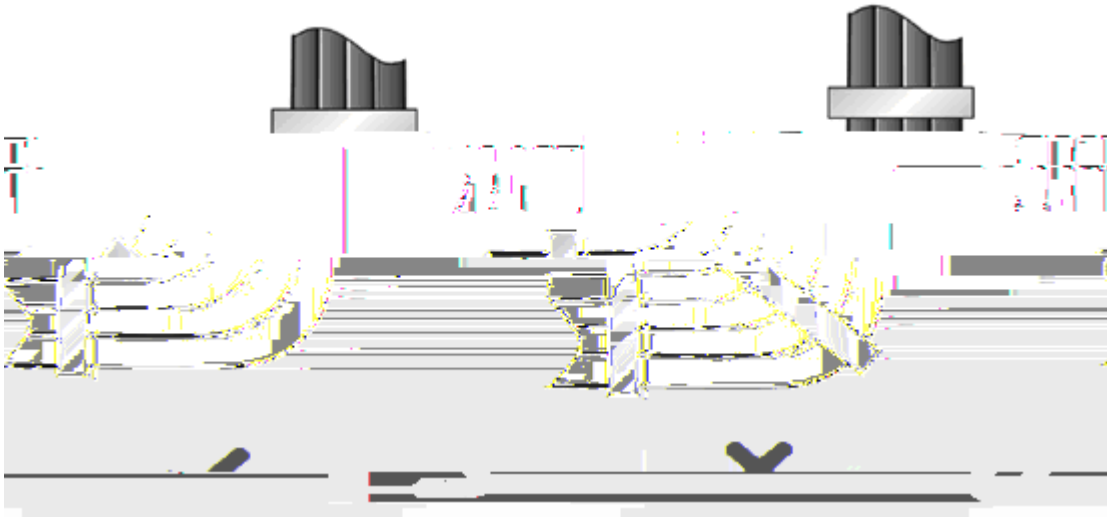

-
-
-

- 3.7km 5km 2km
- 3.7km
-
-
-
-
-
-
- 600mm
-
-
-
-
-