



# **RG-AP620**

**V1.3**

©2000-2012



RGOS®

RGNOS®



锐捷®

<http://www.ruijie.com.cn/>

<http://webchat.ruijie.com.cn>

8:30 6

<http://www.ruijie.com.cn/service.aspx>

7x 24

4008-111-000

<http://support.ruijie.com.cn>

[service@ruijie.com.cn](mailto:service@ruijie.com.cn)

WEB	WEB



# 1

RG-AP620 AP620 AP620  
 AP Fat AP AP Fit AP /

## 1.1 RG-AP620-H

		RG-AP620-H
		1 combo 1 10/100/1000M RJ45 1 SFP 1 console 6
		PoE 802.3at
		25W
	CPU	CN5010 500MHz
		256M
	flash	2MB
	flash	128MB
		AP
		AP
		-40 55

RG-AP620-H 1 10/100/1000M RJ45 1

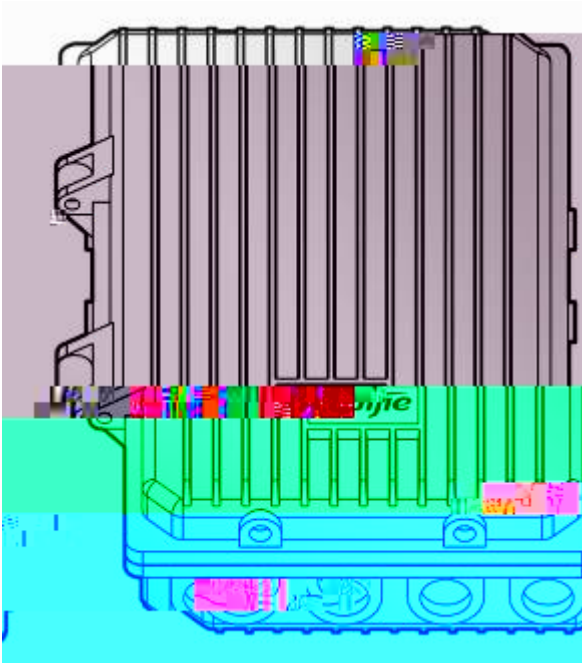

1-2 RG-AP620-H

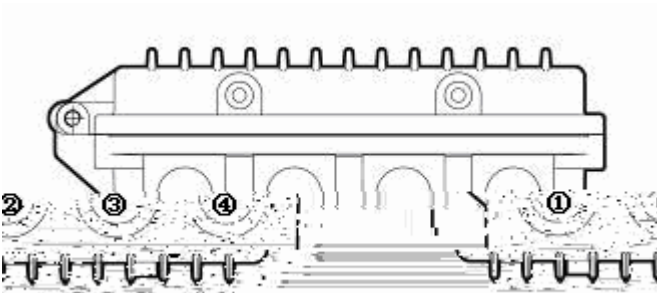

1	3
2	4

1000Base-X SFP  
Console

RG-AP620-H PoE 802.3at  
36-57V~  
0.57A

RG-AP620-H

## 1.2 RG-AP620-H(-S)

---

	RG-AP620-H(-S)
--	----------------

1-4 RG-AP620-H(-S)

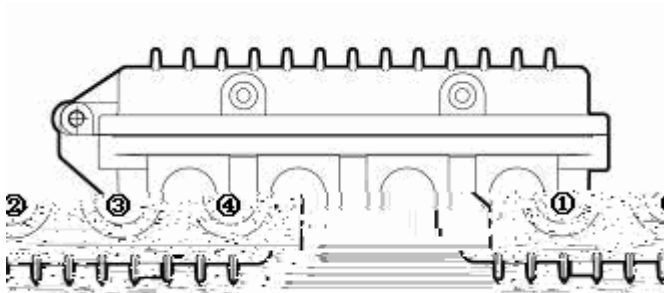

1	3
2 10/100/1000Base-T	4 Console

RG-AP620-H(-S) PoE 802.3at

36-57V~

0.57A

RG-AP620-H(-S)

## 2

---

RG-AP620

---

### 2.1



### 2.2



### 2.2.2

RG-AP620-H

RG-AP620-H(-S)

### 2.2.3

2-1



2-2

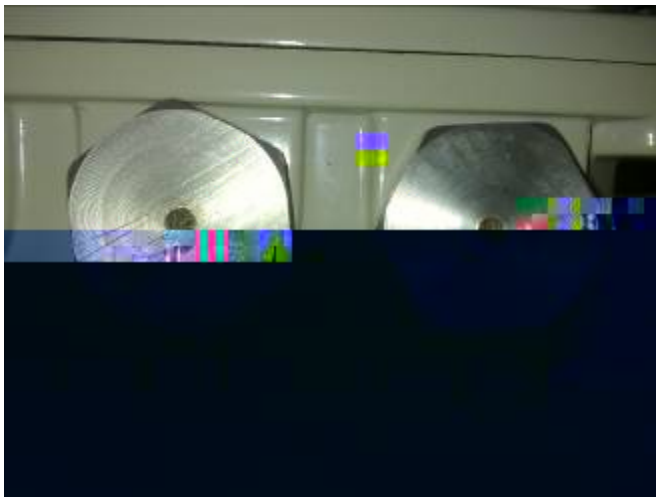

2-3

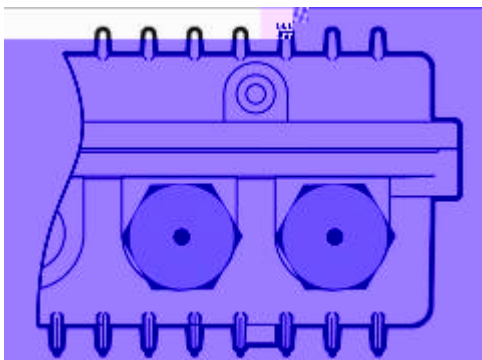

2-4



## 2.2.4 EMI

## 2.3

## 3

---

---

### 3.1

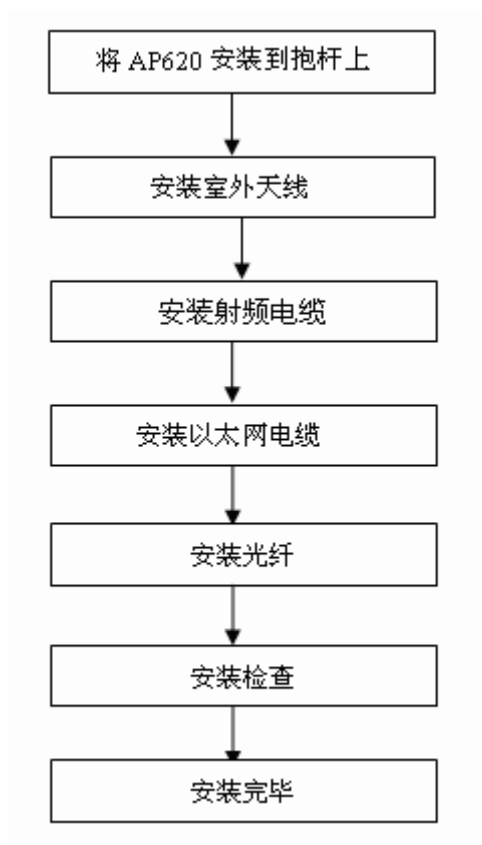

### 3.2

### 3.3

 AP

---

### 3.4 AP620

1)

3-1 AP620

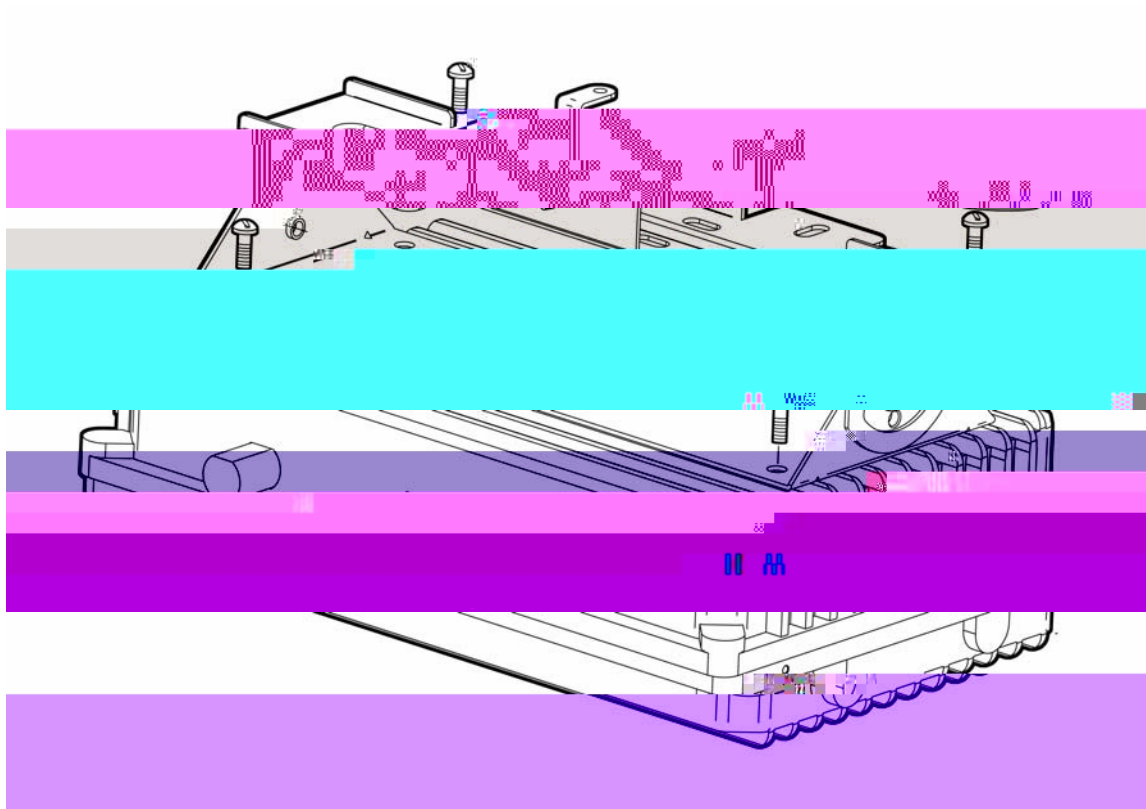

2)

3-2

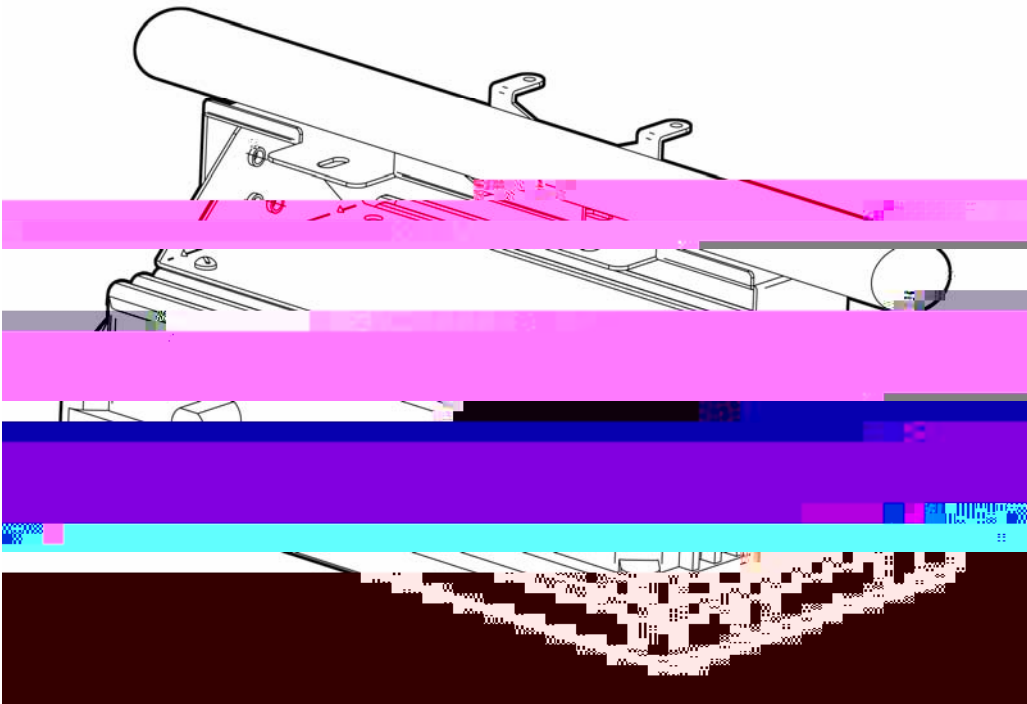

3-3

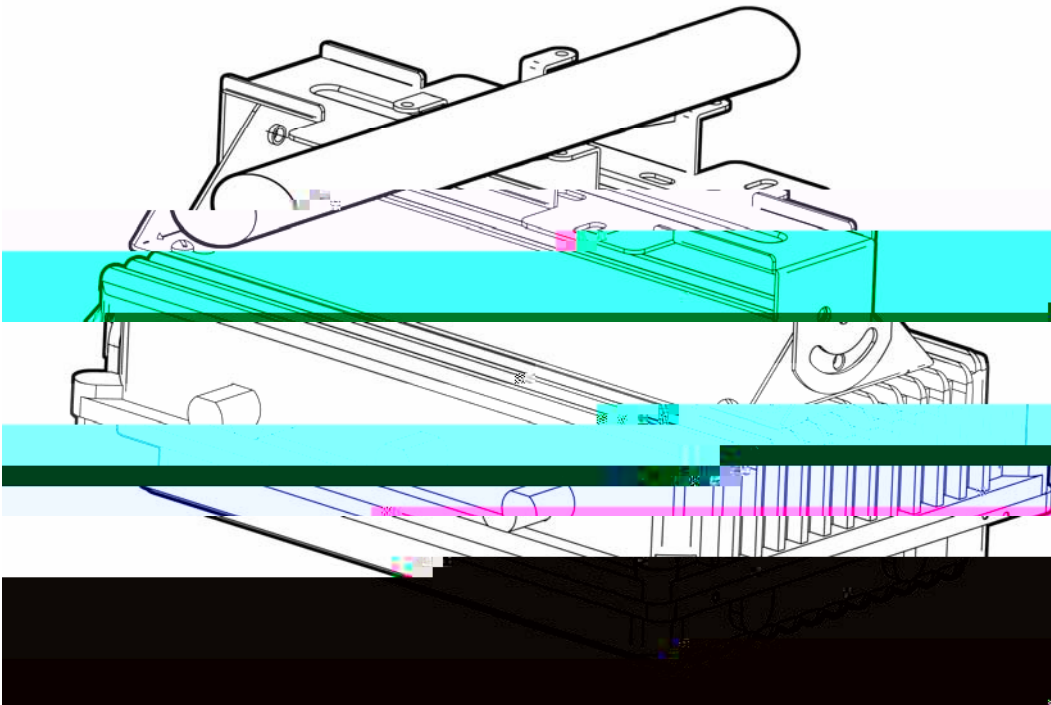

3)

2

AP620

3-4

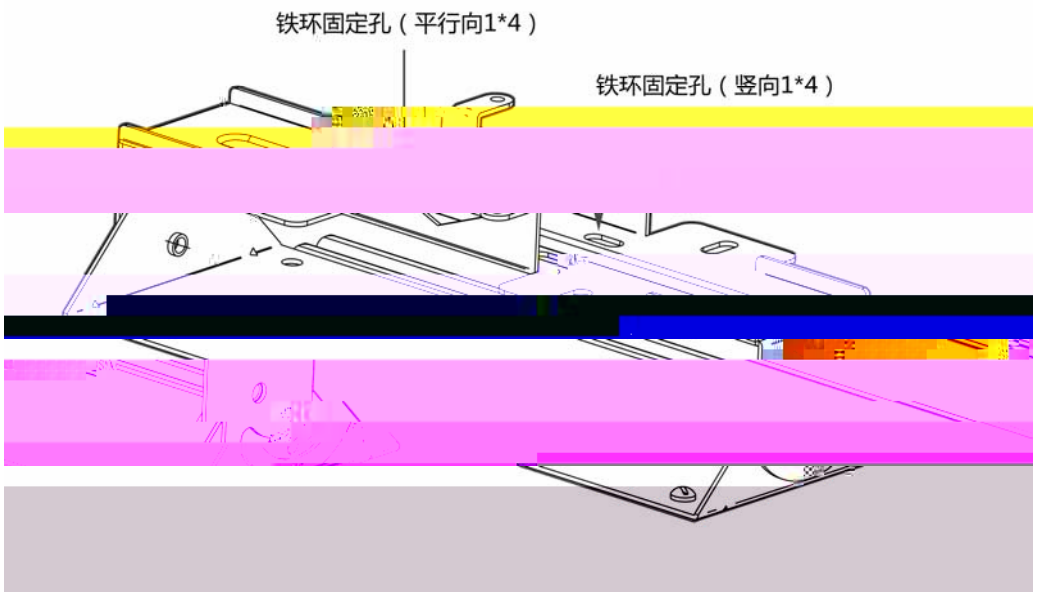

3-5

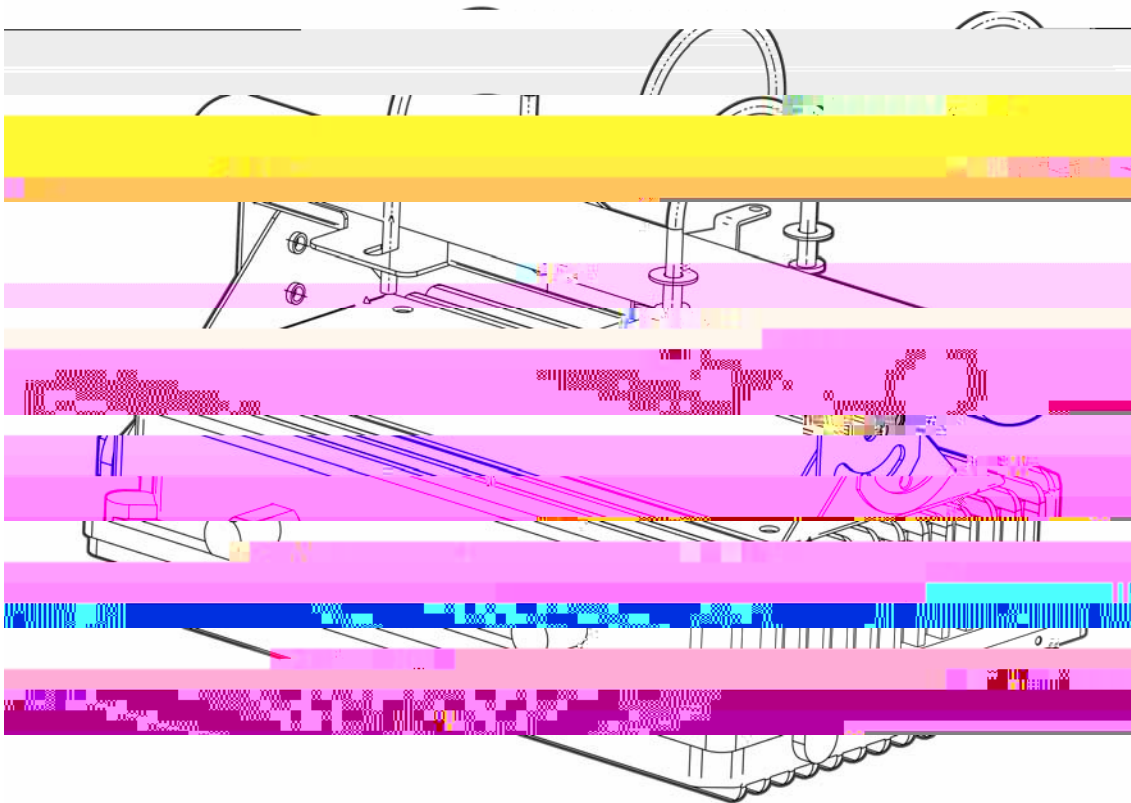

3-6

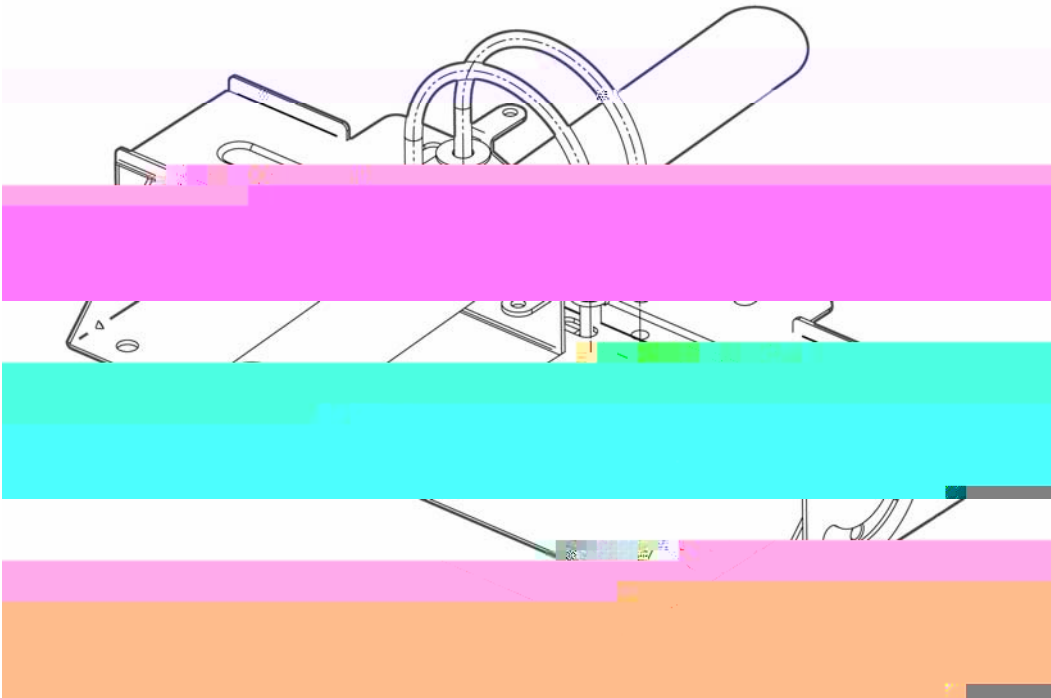

3-7

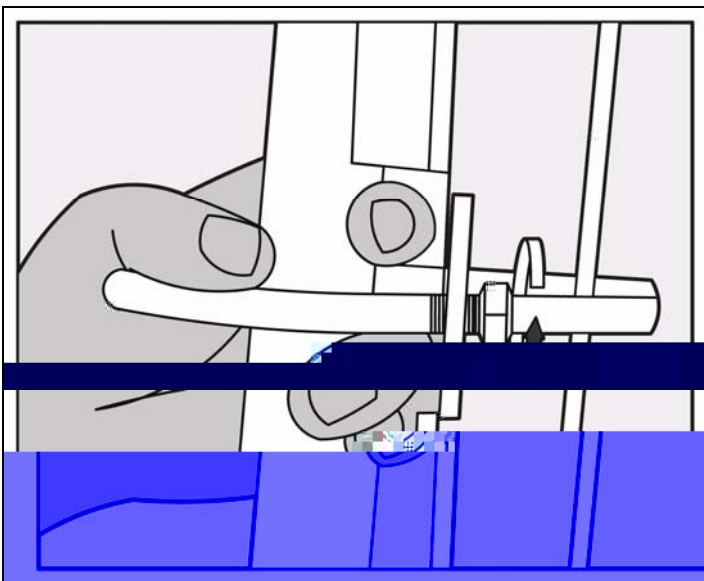

**3.5**



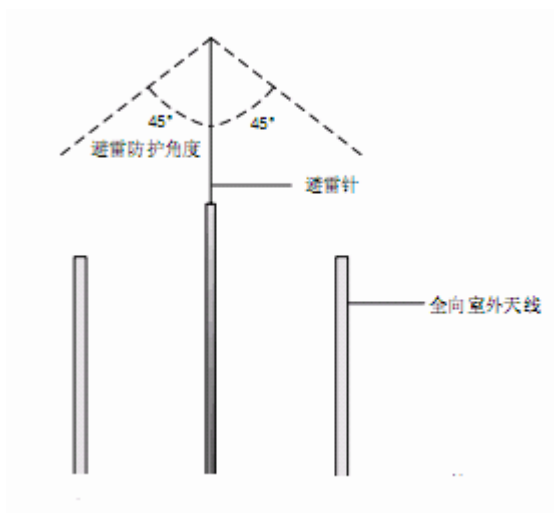

### 3.6

PG9

3-10



PG9

3-11



# A

## 1000BASE-T/100BASE-TX/10BASE-T

1000BASE-T/100BASE-TX/10BASE-T

MDI/MDIX Crossover

1000BASE-T

IEEE 802.3ab

100-ohm 5

UTP



A-4

A-4

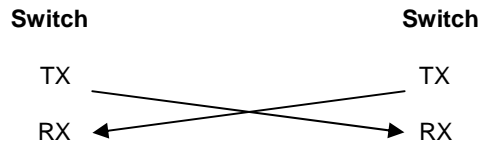

## B Mini-GBIC

SFP SFP Mini-GBIC

**Mini-GBIC SFP**

B-1 SFP

Mini-GBIC(SFP)	(nm)			(MHz/km)		(dbm)
----------------	------	--	--	----------	--	-------